

# GO1

## User Manual V1.4

2021.12



# Unitree

[www.unitree.cc/cn](http://www.unitree.cc/cn)

# CONTENTS

Statements and Warnings.....	3
Product Description.....	5
Introduction .....	5
Feature Highlights.....	5
Unpacking and Packing.....	5
GO1 Quadruped Robot.....	8
Robot Part Name.....	8
Prepare Before Starting Up.....	9
Robot internal architecture.....	10
Robot Operating Mode.....	10
Startup and Shutdown.....	11
Battery Pack.....	12
Foot Assembly.....	16
Remote Control Module.....	19
Joystick Introduction.....	19
Joystick Operation.....	20
Label controller.....	23
Label controller Introduction.....	23
Function.....	24
Follow the instructions automatically.....	25
APP Interface.....	28
website Interface Introduction.....	30
Robot Special Case Handling.....	34
Robot Black Box.....	34
Robot Abnormal Situation Response.....	34
Disclaimer and Safe Use Guidelines.....	37
Environmental Requirements.....	37
Check Before Starting.....	37
Operational Considerations.....	38
Battery Pack Safety Guidelines.....	39
After-sales Policy.....	43
Warranty Period.....	43
Maintenance Method.....	43
Other Rules.....	44
Appendix.....	45
Specifications.....	45
Interface diagram.....	45

# Statements and Warnings

- 1.This product is not a toy and is not suitable for people under the age of 18. Do not allow children to come into contact with this product.
- 2.Please read this document carefully before using the product to understand how to use this product correctly and understand your legal rights, responsibilities and safety instructions; otherwise, it may bring property damage, safety accidents and personal safety hazards. By using this product, you are deemed to have understood, endorsed and accepted all and part of the terms and conditions of this document. The user is committed to being responsible for his or her actions and all consequences arising therefrom. The user undertakes to use the product solely for legitimate purposes and agrees to these terms and any relevant policies or guidelines that may be established by Unitree.
- 3.To the fullest extent permitted by law, Unitree does not make any warranties, express or implied, with respect to this product, including but not limited to warranties of merchantability, fitness for a particular purpose, or non-infringement. To the fullest extent permitted by law, Unitree shall not be liable for any damages resulting from the user's failure to use the product in accordance with this document. Not liable for any indirect, consequential, punitive, incidental, special or penalties, including damages incurred as a result of your purchase, use or inability to use the product (even if Unitree has been advised of such loss) The possibility is also). To the fullest extent permitted by law, in no event will Unitree's general liability (whether in contract or otherwise) to you for all damages, losses and litigation will exceed your purchase (if any). And the amount paid to Unitree.
- 4.The laws of some countries may prohibit exemption from the terms of the guarantee, so your rights may vary in different countries.
- 5.Unitree has the final right to interpret the above terms in compliance with laws and regulations. Unitree reserves the right to update, change or terminate these Terms without prior notice.
- 6.When using robot, please keep the robot within sight, so that the robot keeps a safe distance of at least 2 meters from obstacles, complex ground, crowds, water and other objects at all times! Do not carry the robot after the robot is powered on!
- 7.Do not use the emergency braking function when the robot is not protected by the protective frame and protective rope provided by Unitree in the software manual. Otherwise, it will cause the robot to fall to the ground and cause serious damage !!!
- 8.When the robot is not protected by the protective frame and protective rope provided by Unitree (or there is no artificial support for the robot), please do not cut off the power of the robot by pressing the battery power button, otherwise the robot will fall to the ground!!! For details, please refer to "How to Turn Off the Robot When the Remote Control Module Fails" in "Robot Abnormal Situation

Response" P40.

9. Aliengo is a purely electric quadruped robot with certain anti-jamming, but the energy density of the motor is much lower than the hydraulic pressure. Do not push the robot suddenly and vigorously, nor to kick the robot, so if the robot falls and is damaged due to a sudden and strong push or kick, it will not be covered by the warranty.
10. Please control the robot to a prone position before standby for a long time (when the robot is standing normally, hold down the L2 button and click the A button once to half squatting state, and click the B Button twice to the zero force mode (the four joints are completely unstressed)) to avoid the robot automatically shutting down and falling down damaged due to low power!
11. When there is only one battery level remaining, please stop and turn off the robot in time, take out the battery and charge it, to prevent the robot from falling to the ground and damaged when power is low.
12. Do not use the roll function after configuring lidar, otherwise the lidar or robot will be damaged!!!
13. Do not lift the robot after switching to the sport mode, otherwise the robot may perform unpredictable actions, causing damage to the robot or personnel! ! !

# Product Description

## Introduction

The Go1 high-motion performance quadruped robot platform consists of a quadruped robot, a wireless positioning tag, a remote control and supporting remote control software. The whole machine has 12 degrees of freedom (composed of 12 high-performance servo motors), and the force control technology is used to perform compound control of the force and position of each joint, so as to realize the force control of the whole machine and obtain excellent sports performance. Use streamlined mechanical structure to reduce manufacturing difficulty and improve machine reliability. Equipped with a super-sensing system to realize dynamic perception and the world's first autonomous accompanying function. Whether it is in terms of structure, sports performance and environmental perception, it has reached the leading level at home and abroad.

## Feature Highlights

Go1 expands its accompanying functions and optimizes its performance on the basis of regular sports; the overall body weight is 12kg, which makes the robot very light and easy to carry; Go1 is equipped with an ISS only companion system, using patented wireless vector positioning and The control technology allows the robot to be located in the side of the person's lateral vision, which is far better than the conventional follow mode. The human-computer interaction is natural and harmonious, safe and safe; the body comes with an sss super-sensing system, a fisheye binocular camera and The fusion of ultrasound can make the robot autonomously choose a simpler route to travel while the environment is complex. At the same time, the APP side develops the God's perspective, and uses the robot's own multiple sets of cameras for multi-eye vision fusion, thereby opening the God's perspective of the robot's remote control operation, making the remote operation beyond the visual range as easy and convenient as being on the spot.

## Unpacking and Packing

### Unboxing

Place the box on a flat ground according to the placement requirements (front face up), then open the upper box, and lift the robot as a whole, as shown in the figure above. Take out the quadruped robot, remote control, charger, etc. from the box respectively, place the quadruped robot on a flat ground, untie the velcro straps on the legs of the quadruped robot, and prepare for booting

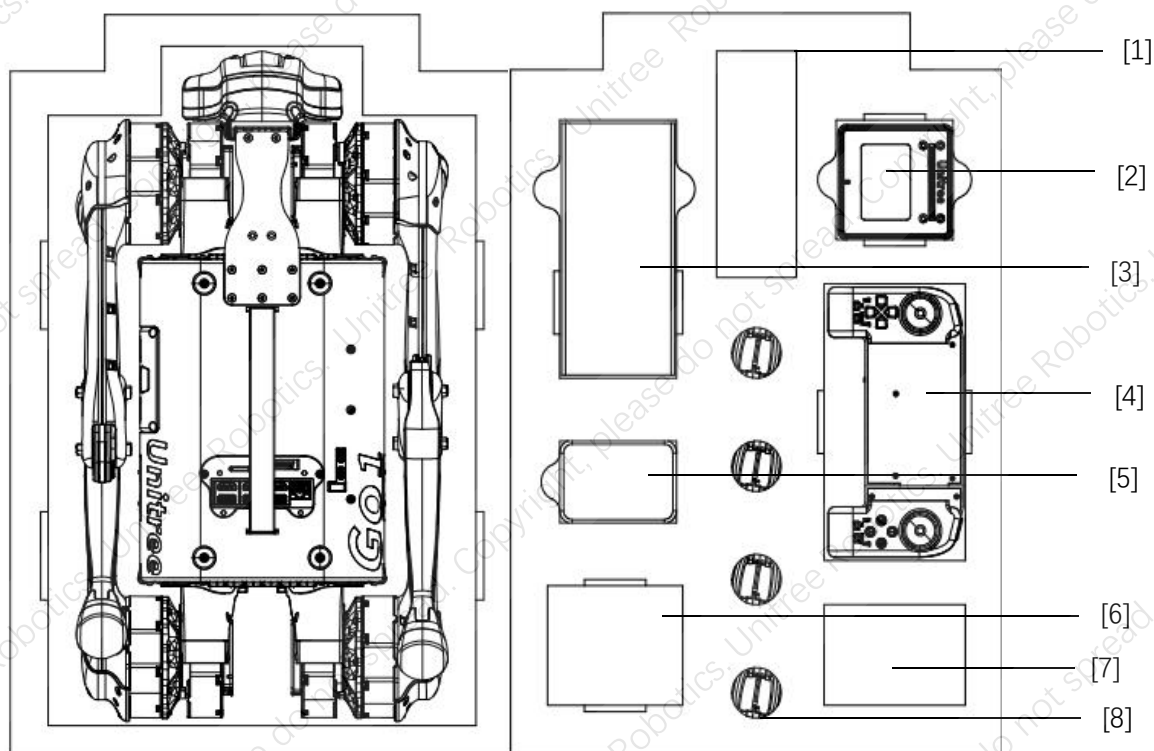

[1]Reserved space    [2] Battery charging dock    [3] Battery charger    [4] Joystick    [5] Tape    [6] Emergency stop button and type-C charger    [7] Reserved space    [8] Foot accessories

## Unpacking

Place the box on the flat ground according to the placement requirements (Face up), then open the upper box and lift the whole robot out, as shown in the figure above. Remove the robot and remote control, charger, etc. from the box, place the robot on the flat ground, untie the velcro strap of the robot's leg, and then prepare for the boot.

## Before Packing

First rotate the legs of the robot to the position shown in Figure [4] above(the rear leg is folded up: rotate the rear leg hip motor so that the rear thigh is placed in the position shown in the above figure [4] above, and the lower leg is closed. Place it in the position shown in Figure [4] above, and tie the left rear leg and the right rear leg together with a Velcro strap, as shown in Figure [3] above. The front leg is folded up: similar to the hind leg, as shown above Figure [3], [4] above placed and bundled).



•If not using the robot for a long time, take out the battery pack and put it into battery box.

# Go1

本章节介绍 Go1 本体及其使用

# GO1 Quadruped Robot

## Robot Part Name

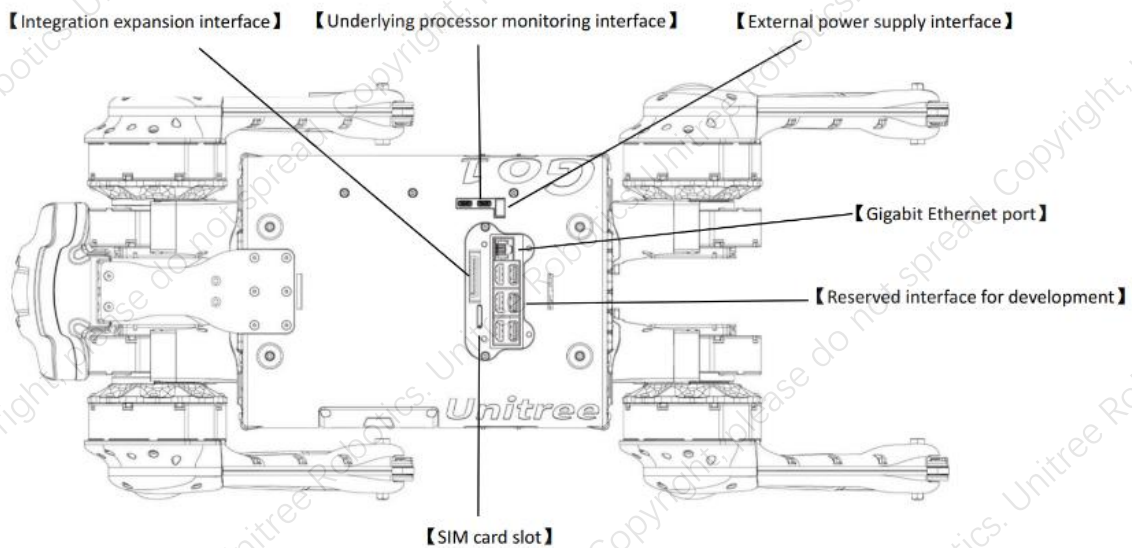
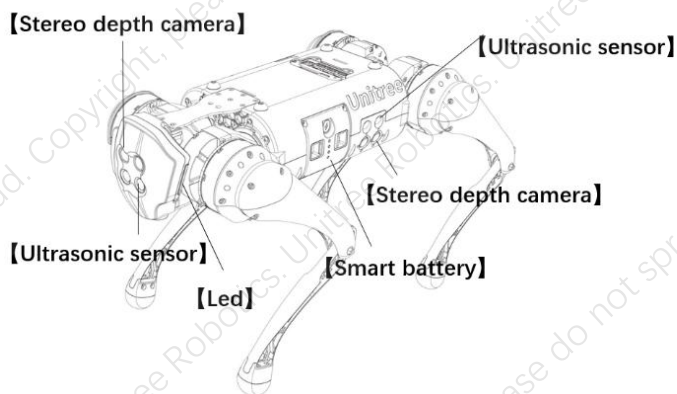
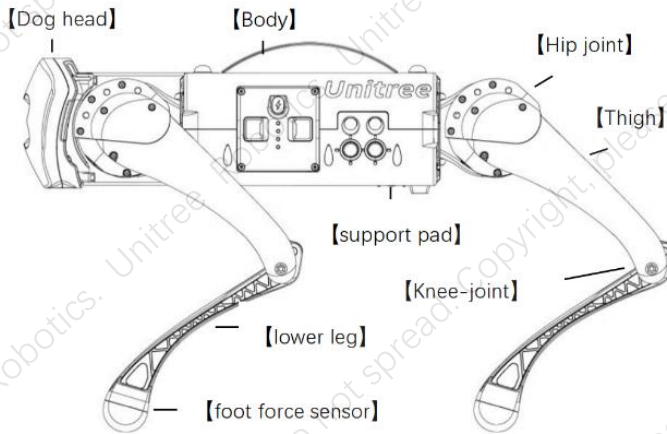



## Prepare Before Starting Up

### Install the Battery Pack

Insert the battery pack into the battery slot from the side of the robot, and pay attention to the installation direction. If the battery cannot be completely inserted, please adjust the battery direction and do not press it forcibly to avoid damaging the battery interface and Clasp.



•Recommended that the battery be fully charged before use robot.

### Body Placement

Horizontal boot: please make sure that the robot is placed on the leveling ground before starting the machine. The robot's abdominal support pad should be flat on the ground. The body level is not tilted on the ground. The robot calf is fully stowed (As shown below) , make sure that the robot's thighs and calves are not pressed by the body, otherwise the robot may fail to boot.

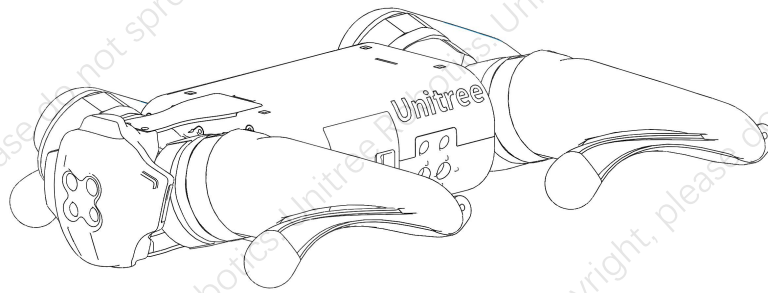

### Connect the remote control module

The remote control module includes a joystick and mobile phone. First press the power button for a short time, and then press and hold the power button for more than 2 seconds to turn on the joystick. The joystick corresponds to the robot data transmission module one by one, and it can be automatically connected after starting. The data transmission signal light on the left side of the handle is fully lit to control the robot; at the same time, the Bluetooth of the mobile phone can be turned on, and the handle can be connected through the APP to view the connection status of the handle and the robot.

The robot dog launches 5G WIFI hotspot for image transmission connection. Enter the phone settings, turn on the WLAN, and find the corresponding WIFI hotspot, namely **UnitreeRoboticsGO1-XXX**, XXX corresponds to the robot dog code. Click to connect, enter the **password 00000000**, the image transmission function is opened after the connection is successful, and the characters can follow and autonomous navigation operations.

## Robot internal architecture

GO1 uses a new hardware architecture and control system, control system as follows:

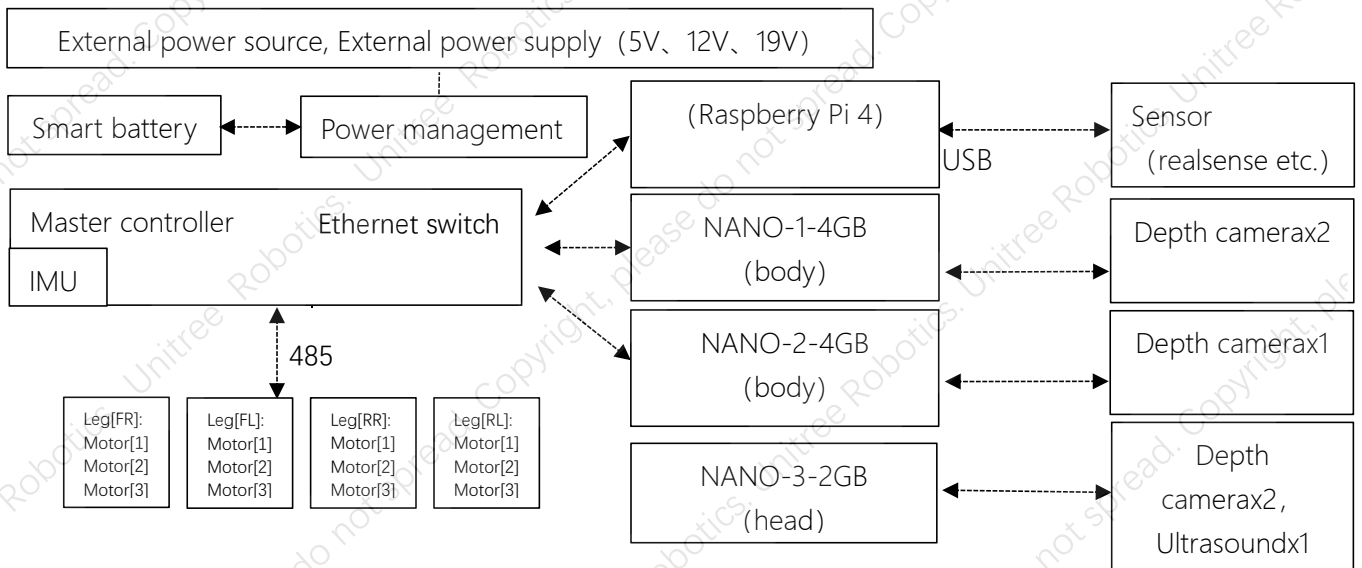

## Robot Operating Mode

The following operating states and operating modes are supported:

### Static standing state:

The static standing state refers to the state where the position of the robot body is at the initial height after the machine is turned on, the body is level, and the handle is not operated. In this state, the power consumption of the whole machine is the smallest, and the longest endurance time can be reached. The 3-axis attitude and 3-axis position control can be completed by the joystick.

### Sports mode:

After the robot is turned on, it will stand up on its own. At this time, it is in the movement mode and can complete walking, fast running and other sports.

### Accompanying status:

After the robot dog is turned on, the head light strip will flash after 1 min. At this time, the robot can be accompanied by the tag controller. The robot can dynamically follow the controller and avoid obstacles dynamically in real time.



- Since the actual control personnel have different levels of control proficiency, in order to be reliable and stable, please use it in an open and flat environment. When operating the robot, be careful to avoid steps above 5cm, slopes greater than 25°, and obstacles that may cause the robot to fall. When the robot is walking on a terrain with a certain undulation or slope, the controller should reduce the walking speed of the robot.
- The robot has certain requirements for the ground to walk. Do not use robot on the ground with very low friction, such as ice. Do not use robot on soft ground, such as thicker sponge floors. For use on smoother floors, such as glass, tiles, etc., carefully and compliantly control the robot to exercise, avoid strenuous exercise, and reduce the walking speed of the robot to prevent the robot's foot from slipping and falling.

## Startup and Shutdown

### Startup

After placing the robot according to the requirements in the "Preparing Before starting up" section, start the following steps: short press the power switch once, then press and hold the power switch for more than 2 seconds to turn on the battery (when the battery is turned on, the indicator light is the green light is always on and the indicator shows the current battery level). Then the robot will perform the power-on self-test. If the self-test is successful, the robot will stand up to the initial height of the body, and the boot is successful. If the robot is not stand up during the above process, the robot fails the self-test. If the boot fails, the robot can't stand up. At this time, you need to re-start the body according to the two steps of "body placement" in the "Preparing Before Starting Up" section.

### Shutdown

Before shutting down, please make sure that the robot stands on the level of the ground, make sure that the robot is in Static Standing State (the height of the robot body is at the initial height after starting up, the body level, the joystick has no operation, the state when standing statically). Press and hold the handle L2 button, then click the A button three times, the robot will then complete the squat, stand up, and lie down; then hold down the handle L2 button, and then click the B button twice, the robot then completes prone (Damping), prone (undamped) action; after the robot enters the prone (undamped) state, press the power switch once, then press the power switch for more than 2 seconds to turn off battery. When the battery is turned off, the indicators are off. After shutting down, please adjust the size of the robot's size legs and hips according to the requirements in the "Preparation before starting" section, and prepare for the next boot.

After shutting down, please adjust the size of the robot's size legs and hips according to the requirements in the "Preparation before starting" section, and prepare for the next boot.

- The step of shut down will be described in the "Joystick Operation" section.
- Please pay attention to Unitree's official website - service and support - technical support - firmware update or contact Unitree staff. We will develop a one-button shutdown function as soon as possible, and upload the firmware. At that time, the customer can update the firmware to make the robot have a one-button shutdown function.

## Battery Pack

### Introduction

The battery pack is designed for the GO1 with a capacity of 6300 mAh and a voltage of 21.6 V with charge and discharge management. The battery pack features a high-performance battery and uses the advanced battery management system developed by Unitree to provide sufficient power for the GO1.



- Be sure to fully charge the battery before using it for the first time.

The battery pack must be recharged using a dedicated charger from Unitree.

### Technical specifications

parameter	Specification	Remark
Rated voltage (power supply)	22.2V	
Rated current (power supply)	无	Current jump
Rated voltage (charging)	25.2V	
Rated current (charging)	6A	
Rated Capacity	6000mAh,133.2Wh	
operation hours	约 1h	
frequency	4243.2–4742.4 MHz	

## Battery Pack Function

The battery pack has the following features:

- 1. Battery Display:** The battery has its own battery indicator, which can display the current battery level.
- 2. Battery Storage Self-discharge Protection:** When the power of battery is higher than 65% After 10 days without any operation, the battery can start self-discharge to 65% to protect the battery. Each self-discharge process lasts for about 1 hour. There is no LED light indication during discharge, and there may be slight heat, which is normal.
- 3. Balanced Charge Protection:** Automatically balance the internal battery voltage of the battery to protect the battery.
- 4. Overcharge Protection:** Overcharging can seriously damage the battery, our battery can automatically stop charging when it is fully charged.
- 5. Charging Temperature Protection:** Charging will damage the battery when the battery temperature is below 5 °C or above 55 °C. At this temperature, the battery will trigger charging abnormality.
- 6. Charging Current Protection:** High current charging will seriously damage the battery. When the charging current is greater than 4A, the battery will stop charging.
- 7. Over-discharge Protection:** Over-discharge will seriously damage the battery. When the battery is discharged to 18V, the battery will cut off the output.
- 8. Short Circuit Protection:** When the battery detects a short circuit, the output will be cut off to protect the battery.
- 9. Battery Load Detection Protection:** When the battery is turned on, if no powered device is connected, the battery will automatically shut down after 3 seconds.



• Please read and strictly follow requirements of Unitree in this manual, disclaimer, the sticker on battery pack surface and dedicated charger surface before using the battery pack. The consequences of failure to use as required are borne by the user.

## Battery Pack Part Name

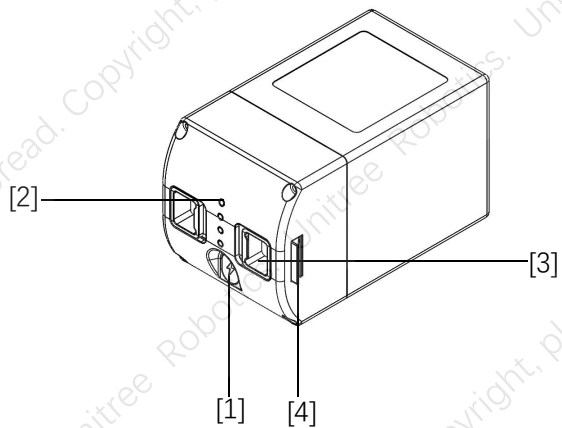

[1] Power switch

[2] LED1

[3] Snap

[4] Tab

[5] Charger interface

[6] Batteries

[7] Plug-in interface

Battery pack charger interface.

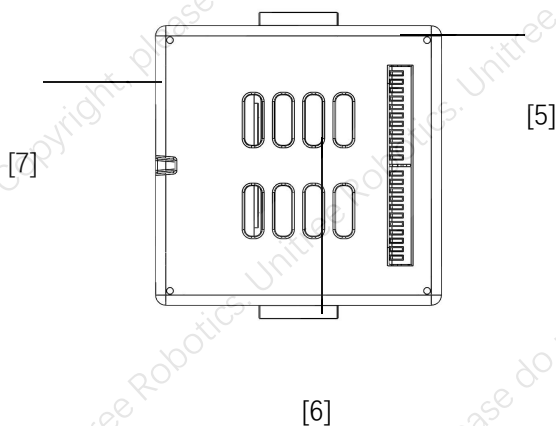

### Turn the Battery On/Off

**Turn on the Battery Pack:** In the off state, first press the power switch once, then press and hold the power switch for more than 2 seconds to turn on the battery. When the battery is turned on, the power indicator is steady green and the battery indicator shows the current battery level.

**Turn off the Battery Pack:** In the on state, short press the power switch once, then press and hold the power switch for more than 2 seconds to turn off the battery. When the battery is turned off, the indicators are off.

### Precautions For Use:

1.The battery pack should be used between 5 °C and 40 °C, and the temperature is too high (above 45 °C), which may cause the battery pack to catch fire or even explode. If the temperature is too low (below 0 °C), the battery pack life will be seriously damaged.

2.Do not use the battery pack in strong magnetic or static environments. Otherwise, the battery pack

protection board will malfunction, causing the battery pack and the robot to malfunction.

- When the battery pack charge is less than two compartments, stop using the robot as soon as possible, replace the new battery pack or charge the battery pack.
- Before inserting or removing the battery pack into the robot battery compartment, make sure that the battery pack is closed, otherwise the battery pack or the robot may be damaged.

## View Battery





































When the battery pack is off, press the battery switch once to view the current battery level.

 The battery indicator can be used to display the battery level during charging and discharging of the battery pack. The indicators are defined as follows.

 Indicates that the LED light is always on

 Indicates that the LED light is flashing

 Indicates that the LED light is off

















Battery Level LEDs				
LED1	LED2	LED3	LED4	Remaining Battery
				87.5%-100%
				75%-87.5%
				62.5%-75%
				50%-62.5%
				37.5%-50%
				25%-37.5%
				12.5%-25%
				0%-12.5%
				=0%

## Charging

- Connect the charger to an AC power source (100-240V, 50/60Hz). Before connecting, you must ensure that the external power supply voltage matches the rated input voltage of the charger, otherwise the charger will be damaged (the rated input voltage of the charger is indicated on the charger nameplate).
- Before charging the battery, the charger is connected to the AC power supply before the battery is connected.
- Before charging the battery, please make sure the battery pack is off, otherwise it will damage the battery and charger.
- Under the charging state, battery indicator will flash in a cycle and indicate the current battery level.
- When the battery indicator is off, the battery pack is full. Please remove the battery pack and charger.

























to complete the charge.

6. After the robot is running, the battery pack temperature may be high. The battery pack must be charged after the battery pack temperature drops to room temperature.

Charging Indicator				
LED1	LED2	LED3	LED4	Current Battery
				0%-25%
				25%-50%
				50%-75%
				75%-100%
				Full

## Charging Protection Indication

The LED can display information about battery protection triggered by abnormal charging.

Charging Indicator					Display Rule	Protection Project
LED1	LED2	LED3	LED4			
				LED2: 2 times/sec	Excessive charging current	
				LED2: 3 times/sec	Short circuit	
				LED3: 2 times/sec	Overcharge causes battery voltage be too high	
				LED3: 3 times/sec	Charger voltage is too high	
				LED4: 2 times/sec	Charging temperature is too low	
				LED4: 3 times/sec	Charging temperature is too high	

Troubleshoot (charge current is too large, charge short circuit, charge overcharge causes battery voltage is too high, charging voltage is too high), please re-plug the charger to resume charging. If the charging temperature is abnormal, please unplug the charger first. After the charging temperature returns to normal, plug in the charger and recharge.



- For safety reasons, the battery needs to be discharged during transportation. The discharge mode is divided into active discharge and passive discharge:
  1. Active discharge: Run the robot until the battery is at a low battery (eg 50% or less).
  2. Passive Discharge: The battery is stored in self-discharge protection. For details, please refer to the chapter "Battery Pack" - "Battery Pack Function".

## Foot Assembly

### Introduction

The foot assembly adopts a new design. The movement of the robot will compress the air in the foot pad and send the pressure signal through the air pipe to the pressure sensor in the shoulder, so as to judge the environment the robot is in and adjust the movement of the robot accordingly.

Foot end components include foot end base, bottom curved rubber pad, air needle and other



components. It can increase the friction of the foot, avoid the damage of the foot, and reduce the impact on mechanical parts.

The foot end components are consumables, and the service life is generally 2-6 months (depending on the use frequency, duration and working condition). Especially in the rough ground running wear will be more serious, such as obvious foot pad wear, damage, or found that the robot walking on the ground significantly increased impact noise, please replace the foot components in time, so as not to damage the foot, resulting in the robot movement disorder.

### Foot Assembly Replacement Method

Remove the [3] foot cap screws, and gently rotate the [1] air needle and [5] rubber trachea connected in the [6] connection slots; Attach the new foot assembly air needle to the rubber trachea (make sure the connection does not loosen easily), and then install the foot end component in the corresponding position of the lower leg (note that the foot end component is divided into left and right parts, the directions are different), and then tighten the screws.

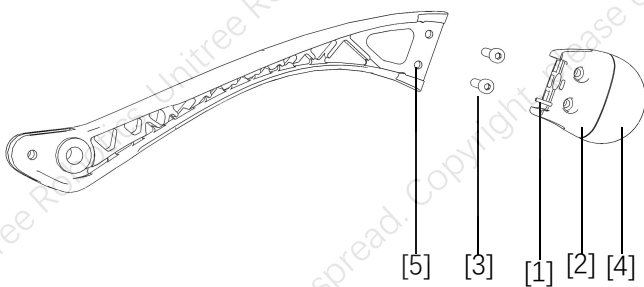

- [1] Air Needle
- [2] Foot Protection Cover
- [3] Foot Cap Screws
- [4] Rubber Foot Pads
- [5] Gas needle trachea connection groove

## Remote Control

---

This chapter introduces the Unitree handle and its use

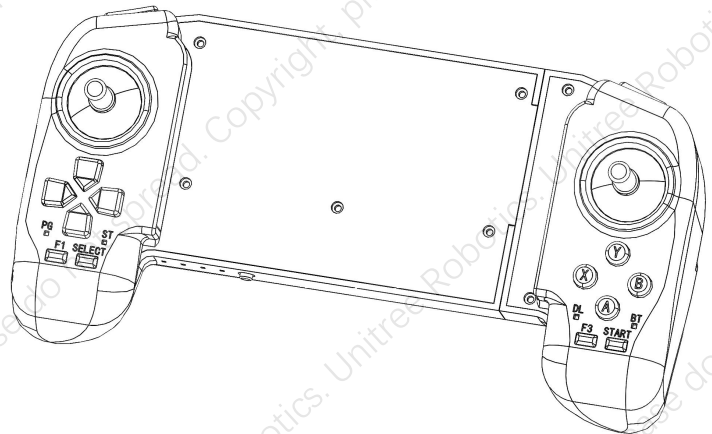

# Remote Control Module

## Joystick Introduction

The joystick belongs to a part of the remote control module, which can control the robot to realize the 3-axis attitude and the 3-axis position control when standing. It can also control the robot to realize the forward and backward, the left and right side shift, the in-situ turn and the certain rule walking on the leveling ground. (straight line, circle, arc, rectangle), crawl forward, up and down slope / step, etc. Joystick through bluetooth connection to mobile phones, the signal transmission is more convenient and stable; Ergonomic structure for a more comfortable feel.

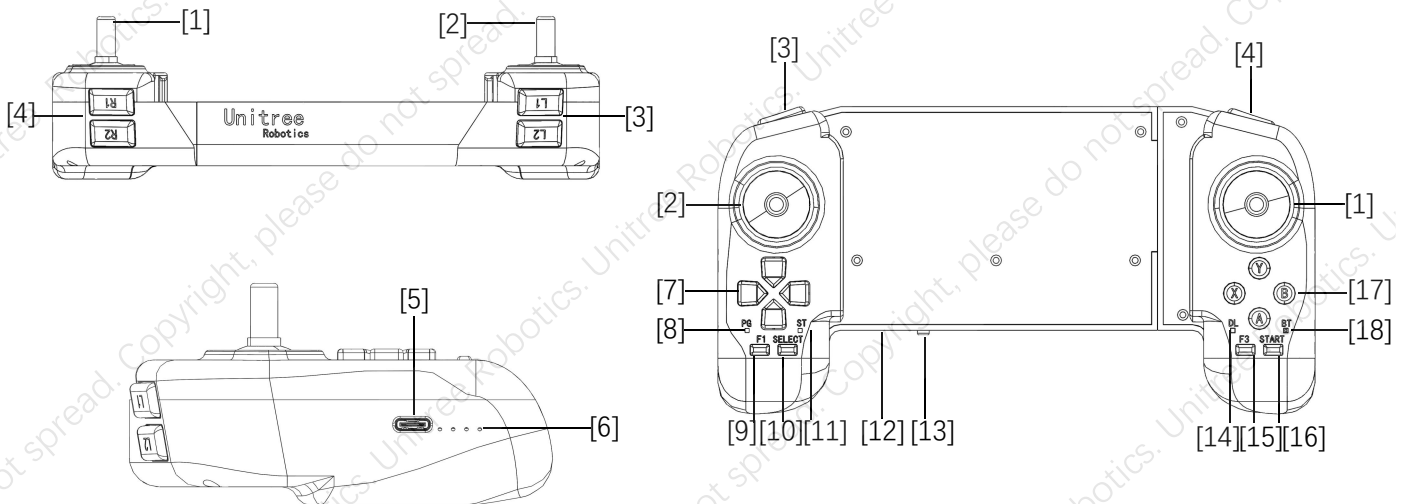

[1] Right Stick [2] Left Stick [3] L1/L2 Button [4] R1/R2 Button [5] Charging Interface Type C  
 [6] Data transmission Signal Light [7] Left Button [8] Power Connection indicator [9] F1 (Left Stick Calibration Button) [10] SELECT Button [11] Charging Status Indicator [12] Battery Power Indicator  
 [13] Power Button [14] Data Link Indicator [15] F3 (Right Stick Calibration Button) [16] START Button  
 [17] Right Button [18] Bluetooth Signal Indicator

## Charge the Joystick

When the battery indicator of the joystick shows low battery (the same status as the battery low battery indicator), the joystick should be connected to the charger, as shown in the figure below:

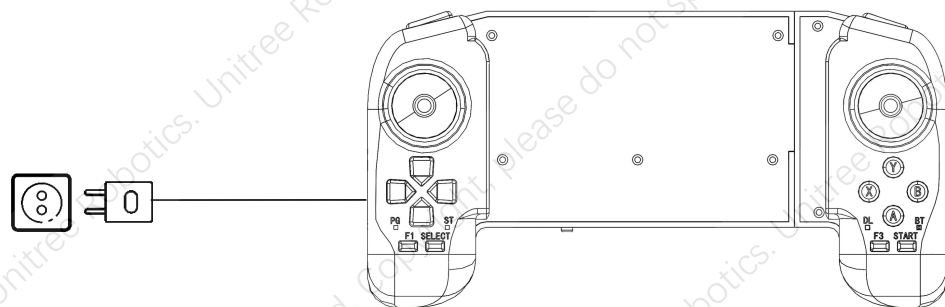

## Technical specifications:

parameter	Specification	Remark
Charging voltage	5.0V	
recharging current	2A	
Lithium battery capacity	3000mAH	
Communication	Digital transmission, wifi, bluetooth	
operation hours	5h	
Distance	Above 100M	

## Joystick Operation

### Installing the Remote Control Module

The joystick is part of the remote control module. The joystick has a built-in Bluetooth module and Data transmission module. The mobile phone communicates with it through Bluetooth connection.

Press the power button for a short time, and then press and hold the power button for more than two seconds, and you hear a "drip~ ", that is, the remote control is turned on.

Press the power button for a short time, and then press and hold the power button for more than two seconds, and you hear three "drip~ drip~ drip~", that is, the remote control is turned off.

### Joystick calibration

Hold the remote control but do not touch the joystick. Press the remote control buttons F1 and F3 and release them at the same time. At this time, the remote control will emit a continuous "drip ~ drip ~" sound (1 time / second) to indicate that it has entered the calibration mode. After entering the calibration mode, move the left and right joysticks to full rudder and rotate it several times until the "drip ~ drip ~" sound stops, and the calibration is ready. Press F3 once to make the calibration take effect and complete the calibration.

**Note :** Please do not touch the joystick before calibrating, only enter the calibration mode to move the joystick. After calibration, you can view the status of the joystick after calibration through APP.

## Control the Robot (Use the Joystick to Manipulate the Robot)



- Stick back to center/center: The Stick of the joystick is in the middle position.
- Stick lever amount: The offset of the remote control joystick from the center of the joystick.
- Walls, doors and other obstructions can greatly weaken the signal between the robot and the remote control module. Please be sure to operate the robot in an open space.

### Before Reading

When using the official control program of Unitree, the operation guidance and robot actions in the table in this section correspond to each other. When the user runs the program developed by himself in the developer mode: the handle command is still valid during high-level (application layer) development. At this time, if the high-level API command and the handle command are sent to the robot together, the robot will execute both commands, which may cause the robot Instability, please be sure to judge whether you need to use the handle control according to the running state of the robot. The handle command is invalid during the low-level development. New players can learn the operation through the operation video tutorial or the quick start manual This chapter is also a chapter that old players need to check frequently



- Since the robot does not have a visual perception system at present, and the actual control personnel have different levels of control proficiency, in order to be reliable and stable, please use it in an open and flat environment. When operating the robot, be careful to avoid steps above 5cm, slopes greater than 25°, and obstacles that may cause the robot to fall. When the robot is walking on a terrain with a certain undulation or slope, the controller should reduce the walking speed of the robot and carefully control it so that the robot is tripped by obstacles.
- Foot robots have certain requirements for the ground to walk. Do not use robots on the ground with insufficient friction, such as ice. Do not use robots on soft ground, such as thicker sponge/turf floors. For use on smoother floors, such as glass, tiles, etc., carefully and compliantly control the robot to exercise, avoid strenuous exercise, and reduce the walking speed of the robot to prevent the robot's foot from slipping and falling.

## Label controller

---

This section describes the features of the label controller and includes instructions for controlling the quadruped robot.

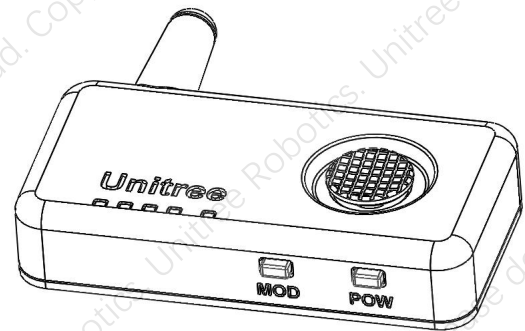

# Label controller

## Label controller Introduction

The tag is part of the Go1 remote control module. It can control the robot to achieve full control of the 3-axis posture and 3-axis position stability when standing, and it can also control the robot to move forward and backward, move left and right, turn on the spot, and walk according to certain rules on a flat ground. (Straight

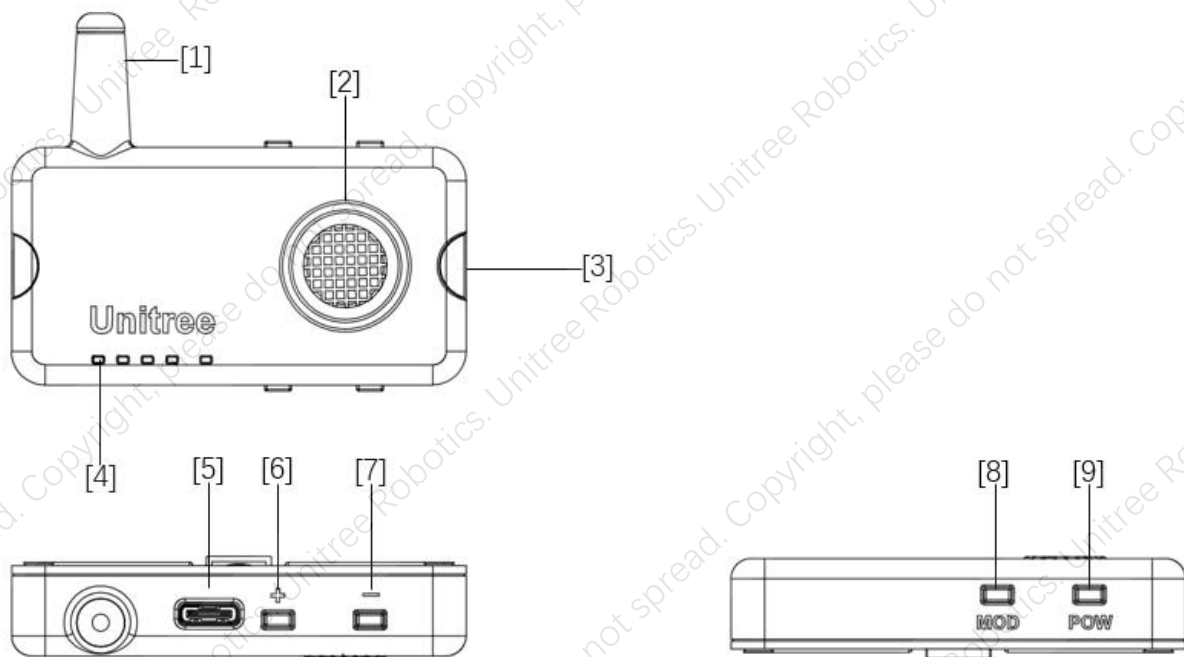

line, circle, arc, rectangle), creeping, up and down slopes/steps, running in place, etc. The handle adopts a new folding design, which is more convenient to carry

[1] Receiving antenna [2] Control joystick [3] Infrared rays [4] Battery indicator [5] Charging port Type C [6] (+) [7] (-) [8] MOD button [9] POW button

## Technical specifications:

parameter	规格	备注
Charging voltage	5.0V	
recharging current	500mA	
Lithium battery capacity	300mAH	
stand-by current	5uA	
operation hours	5h	
Remote control distance	Above 15M	
frequency	4243.2~4742.4 MHz	
The allowable height of the remote control from the ground when following sideways	0.6m~1.2m(Approximately at the waist of the human body)	

### Button Description:

button	Function	Instructions
POW	Power on and off and system reset	<p>Short press once to check the battery level.</p> <p>Short press once, then long press for 2 seconds to turn on and off the remote control.</p> <p>Long press for 8 seconds, the system will automatically reset.</p> <p>Short press twice in a row, and the robot will cycle through the three modes of lying down, damping and standing up.</p> <p>When the robot rolls over, press and hold for 1 second to resume standing.</p>
MOD	Mode Switch	<p>Short press the MOD button once to turn off tracking and enter the joystick control mode.</p> <p>Quickly and shortly press the MOD button twice to turn on the slow auto follow mode, the maximum speed is 1.5m/s.</p> <p>In the slow auto-following mode, quickly short press the MOD key twice again to enter the fast</p>



		auto-following mode, the maximum speed is 3.0m/s.
A	Obstacle avoidance function (not yet enabled)	Short press twice in a row to turn on obstacle avoidance; Short press once to turn off obstacle avoidance.
B	Robot orientation setting	Adjust counterclockwise. Press the B button once (<1s), and the robot will rotate 0.1 rad (about 5.7 degrees) in the counterclockwise direction by default. Adjust clockwise. Short press the B button twice, the robot defaults to 0.1 rad (approximately 5.7 degrees) in the counterclockwise direction.

## Follow the instructions automatically:

**Step1:** Start the robot

·Short press and long press the Go1 power button, and wait for the robot system to start up.

**Step2:** Turn on the companion function on the mobile APP

Connect the mobile phone to the robot dog wifi and open the Go1 APP

·Click, the upper right corner settings-Peripheral Management-UWB tab

·Click OFF to turn on the companion function·

**Step3:** Wear and start the remote control (**important step**)

· Buckle the remote control to the waist belt on the right side of the human body. The human body is standing on the left side of the robot, with the torso facing the same as the robot. Short press and long press the POW button that automatically follows the remote control, when the indicator lights up steadily, the opening is completed, and the remote control is in joystick mode at this time. (If it is already in the power-on state, turn off and re-power on)

**Step4:** Start follow mode

Quickly and shortly press the MOD button twice to turn on the slow auto follow mode, the maximum speed is 1.5m/s.

In the slow auto-following mode, quickly short press the MOD key twice again to enter the fast auto-following mode, the maximum speed is 3.0m/s.

**Step5:** Robot orientation adjustment (**not a necessary step**)

·Short press the B button (<1s), the robot rotates 0.1 rad (about 5.7 degrees) in the counterclockwise direction by default. Adjust clockwise.

Short press the B button twice, the robot defaults to 0.1 rad (approximately 5.7 degrees) in the counterclockwise direction.

**Step6:** The obstacle avoidance function is turned on and off **(not yet turned on)**

Short press the A key twice to turn on obstacle avoidance; short press once to turn off obstacle avoidance.

**Step7:** follow automatically

·After the above operations, the side edge can be automatically followed.

·Notes for automatic follow:

1. The speed cannot be too fast (slow mode is less than 1.5m/s, fast mode is less than 3.0m/s)
2. The automatic follower remote control cannot be placed too high (within about 20cm~70cm from the height of the robot's head);
3. When there is obvious obstruction between the human and the robot, there is a possibility that the robot will lose the actual position of the human. Therefore, when the actual user uses it, it can make the human and the robot in a relatively ideal travel route;
4. When conditions permit, choose a more open route to minimize the triggering of the autonomous evasion function of the robot itself;

**Step8:** Turn off the automatic follow function

·Close the automatic follow function method:

1. Short press the MOD key once: Short press the MOD key once to turn off tracking and enter the joystick control mode.
2. Toggle the joystick: Toggle the joystick to immediately stop following mode and enter the joystick mode.
3. Power off: short press and long press the POW button of the automatic follow remote control to turn off the automatic follow remote control.
4. Horizontal placement: the remote control is placed horizontally.

**Follow the instructions automatically:**

- **Joystick control:** After the remote control enters the joystick mode, the robot can be controlled by the joystick. Using the joystick control mode, you can take the remote control off the belt for control. If you need to continue to use the auto follow mode after the remote control is taken off, you need to wear the remote control where it was when it was turned on, or turn off the remote control, re-wear and start the remote control.
- **Stand up, fall down, and damping modes:** Short press twice in a row, and the robot will switch between three modes: down, damping and standing up cyclically.
- **Roll over:** When the robot rolls over, press and hold for 1 second to resume standing.

**Notice:**

The APP and the tag controller cannot control the robot at the same time. If you need to use the tag control, please do not use the APP to control the robot

## APP

---

This section introduces the main functions of the Unitree Robotics app.

# APP Interface

UnitreeRobotics is an application tailored for quadruped robots of Unitree. Use of Android and IOS system platforms; It supports touch screen and special joysticks, this section takes UnitreeRobotics APP as an example to explain, the specific interface is subject to the corresponding platform display.

## UnitreeRobotics APP 首页

You can experience the app through the following operations



The APP can realize the following functions:

1. It can simultaneously obtain the image transmission of the fisheye binocular camera and the use of AI human body recognition
2. The robot walking and related functions can be controlled through the APP
3. The main control, power and other information of the robot can be obtained in real time
4. It can realize slam control robot

For related APP instructions, please refer to the "Go1 User Manual"

### Notice:

**The APP side cannot control the robot at the same time as the tag controller. If you need to use APP for control, please turn off the tag controller in advance**

## website

---

This section introduces the main functions of the Unitree Robotics app.

# website Interface Introduction

First connect the wifi of the robot with pc, and then open 192.168.12.1 through the web page to see the following interface, The platform can complete all the functions on the app, and can complete online upgrades for the robot

## 1.System management



2.vision

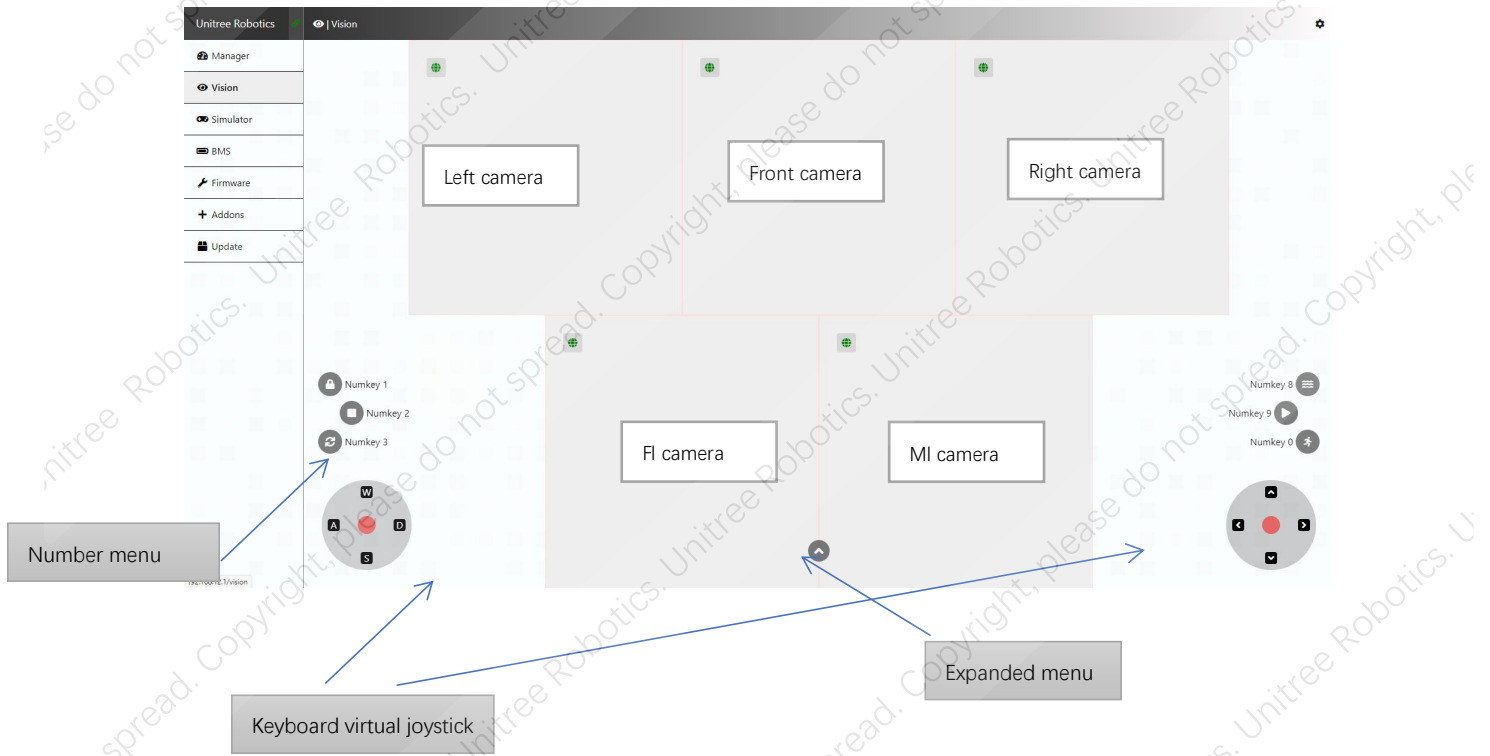

**Description of keyboard virtual joystick:**

Use ADSW and keyboard arrow keys to control the left and right handles, and you can fine-tune when you press the space.

### 3.system update

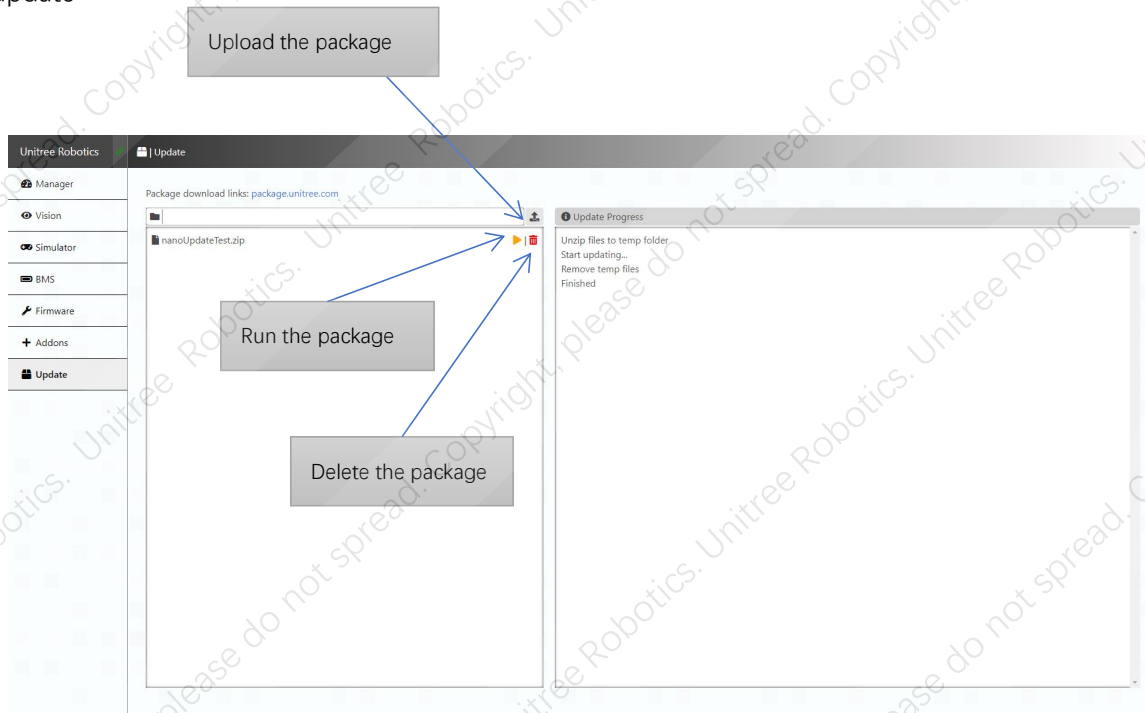

### 4. Emulator





### 5.BMS

Unitree Robotics		BMS	
Manager	Version: 0.0	Status: 0	
Vision	SOC: 0%	Current: 0mA	
Simulator	Cycles: 0		
BMS	BAT1: 0°C	BAT2: 0°C	
Firmware	MOS: 0°C	RES: 0°C	
Addons	Voltage: 0mV		
Update			

### 6.firmware

Unitree Robotics		Firmware	
Manager	Version: 30		
Vision	Robot ID: 0		
Simulator	SN: 0		
BMS	Right Foreleg: 36°C 35°C 35°C		
Firmware	Left Foreleg: 36°C 35°C 35°C		
Addons	Right Hind Leg: 35°C 34°C 34°C		
Update	Left Hind Leg: 34°C 34°C 34°C		

# Robot Special Case Handling

Unitree uses a streamlined mechanical structure to reduce manufacturing difficulty and improve machine reliability. Our robots have achieved good levels in terms of structure, dynamic performance, kinematics and cost. The quadruped robots we develop are reliable and cost-effective. They are very suitable for the exploration of scientific and field-level applications as a new four-legged mobile platform, but when the external environment does not meet the requirements of robot operation or improper use by users, The robot will have some abnormalities. **In addition, in the developer mode, the user will use the program developed by himself on the robot. This has great uncertainties and may cause damage to the robot. Therefore, in the developer mode, please use the protective frame and rope attached to the Unitree official.**

## Robot Black Box

The robot black box is mainly used to record the state information of the robot operation. After the robot fails,, it can help the maintenance personnel to determine the cause of the machine fault more quickly, and judge whether the cause of the machine fault belongs to the user's improper operation or the robot hardware problem according to the black box data. After the robot is turned on, the robot black box will record the machine's IMU, joint angle, joint speed, force sensor and other robot attitude data, as well as internal historical data such as customer control commands and robot running time.



- Improper user operation causes the machine to malfunction and is not covered by the warranty. Please use it in strict accordance with the operating instructions.

## Robot Abnormal Situation Response

### Post-test failed

Short press the power switch once, then press and hold the power switch for more than 2 seconds to turn on the battery. When the battery is turned on, the indicator light is steady green and the indicator light shows the current battery level. Then the robot will perform the power-on self-test. If the music is not heard, the robot fails the self-test, the boot fails, and the robot can't stand up. In this case, you need to follow the "body placement" and "check line" in the "Preparation before boot" section. Cable "two steps to re-boot the body before starting the work.

### Robot Fall Self-protection

When using Unitree's official motion control program, if the robot is unstable and falls due to external environment reasons (not enough ground friction, etc.) or improper operation by the user, the robot

will switch to the self-protection state and the robot's motor will automatically switch. Go to the brakes to protect the parts.

### Emergency Braking (Before Using this Function, Make Sure that the Unitree Official Protection Frame and Rope are Used to Protect the Robot)

Under the developer mode, if the robot is out of control, you can cut off the power of the built-in power distribution board of the robot by pressing and holding the OFF button for 1 second. The robot will lose power. If there is no protection frame protection, the robot will directly drop. The electric fell to the ground. If you need to restart the robot, you need to turn off the battery pack, adjust the robot to the power-on state, and then start the machine according to the normal process.

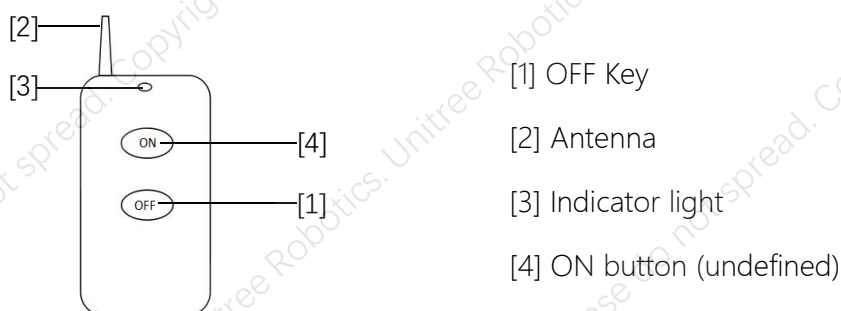

- In the case of emergency braking, if the robot does not have a protective frame protection, it may cause the robot to break. Therefore, in the developer mode, the user must ensure that the robot protects the robot by the protection frame and the protection rope.
- When users use their own programs, there is a lot of uncertainty, the robot may do some unexpected actions (Uncontrolled to the crowd, rushing to the water, high places Fall, leg movements, tumbling). May cause damage to the robot.
- One robot corresponds to a dedicated emergency brake remote control (the robot and the emergency brake remote control are bound to each other), and the mixing is invalid.
- Please use the emergency brake remote control within 10m from the robot in an environment with no obstruction and no electromagnetic interference. Otherwise, the remote control distance may be shortened or the remote control may be invalid.

## How to turn off the robot when the remote control module fails

When the remote control module fails (such as the power of the joystick exhausted), the robot can not be used to make the robot dog down until it is flat on the ground. You can only use the battery power button to force the shutdown (note! If you are not ready before the shutdown, it will easily cause the robot to power down and shoot the ground, causing serious damage to the robot).

Preparations before forced shutdown: After passing the nylon belt through the robot suspension board, hold the nylon belt by hand to make it in a tight state (as shown in the figure below). Press the power switch for a short time, and then press and hold the power switch for 2 seconds Turn off the power, and slowly place the robot on the ground after power off.

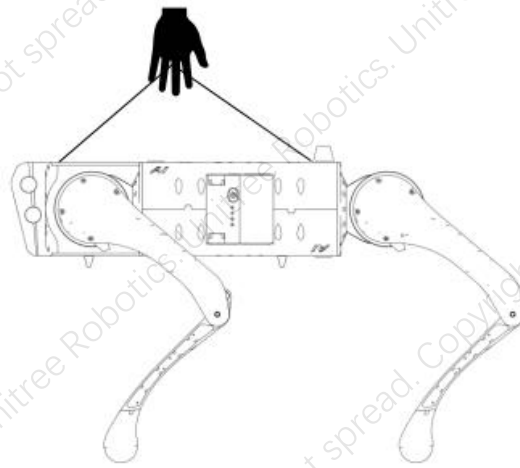

Illustration of preparations before forced shutdown

# Disclaimer and Safe Use Guidelines

## Environmental Requirements

1. Please do not operate the robot in an electromagnetic interference environment. Sources of electromagnetic interference include, but are not limited to, high voltage power lines, high voltage power stations, mobile telephone base stations, and television broadcast signal towers.
2. Please do not run the robot in the environment of WiFi signal interference. WiFi signal interference is usually caused by co-channel interference. When you are disturbed, be sure to turn off some or all of the other wireless device WiFi sources, and then use the remote control to operate the robot.
3. Operate in a good weather environment at 5 ° C -35 ° C. Do not operate in bad weather, such as fog, snow, rain, lightning, sandstorms, storms, tornadoes, etc.
4. When using, please keep the robot within the line of sight to keep the robot at a safe distance of at least 3 meters from obstacles, complex ground, crowds, water surface and other objects.
5. Since the robot does not have a visual perception system at present, and the actual control personnel have different levels of control proficiency, in order to be reliable and stable, please use it in an open and flat environment. When operating the robot, be careful to avoid steps above 10cm, slopes greater than 25°, and obstacles that may cause the robot to fall. When the robot is walking on a terrain with a certain undulation or slope, the controller should reduce the walking speed of the robot and carefully control it so that the robot is tripped by obstacles.
6. The robot is not waterproof, please do not run on the ground with water, rain or snow or humid environment.
7. The robot is not dustproof. Do not run on gravel or dusty environment.
8. Foot robots have certain requirements for the ground to walk. Do not use robots on the ground with very low friction, such as ice. Do not use robots on soft ground, such as thicker sponge floors and grassland. For use on smoother floors, such as glass, tiles, etc., carefully and compliantly control the robot to exercise, avoid strenuous exercise, and reduce the walking speed of the robot to prevent the robot's foot from slipping and falling.

## Check Before Starting

1. Use only genuine Unity parts and ensure that all parts are in good working order.
2. Make sure the remote control and battery pack are fully charged.
3. Make sure the firmware and app have been updated to the latest version (early versions may only support manual firmware updates).

4. Please make sure that the robot is placed on the leveling ground before starting the machine. The robot's abdominal support pad should be flat on the ground. The body level is not tilted on the ground. The robot calf is fully stowed and the robot hip joint is adjusted to open the four legs. Refer to "Body Display" in the "Preparing Before Boot" section.
5. Users ensure that they are not manipulating the robot without drunkenness, drug effects, or inability to concentrate.
6. Be familiar with the characteristics of each gait mode. Familiar with emergency braking method in case of robot instability/uncontrolled.
7. Ensure that there are no foreign objects inside the robot and each component (e.g. water, oil, sand, earth, etc.)
8. Check the condition of the robot cable: whether the cable is damaged, whether the interface is disconnected, and whether the cable is caught in the gap between the hip motor and the front and rear baffles. If the cable is caught in the above gap, the cable should be removed. To prevent damage to the cable.

## Operational Considerations

### 1. Standing Status:

When standing, if the local friction is insufficient or the robot's foot does not have reliable support, do not violently control the robot for posture adjustment (including pitch, roll, yaw, body height adjustment, etc.), otherwise the side may cause the robot to lose stability. inverted.

### 2. Walking Status:

Please walk under the stable terrain control. If you are walking on a ground with less friction, do not violently control the robot to complete the movement. Otherwise, the side may cause the robot's foot to slip and become unstable.

### 3. Battery Life:

4. The rated life of the robot with no-load static standing and upright running alternately is about 1-2.5 hours. It depends on the actual operating conditions of the robot, such as long-time faster walking, long-term adjustment of the body posture when the robot is standing, robotic leg bending standing, running with load, lower body height walking, appropriate Conditions such as undulations and slope topography will reduce battery life. (The height of the body is low, and when the knee joint is relatively large, the burden on the motor is large, so the power consumption is significantly increased early, and the motor is heated).

### 5. About Steps and Undulating Pavement:

6. Since the robot does not have a visual perception system, and the actual controller has different levels

of proficiency in control, the current version does not recommend the customer to walk more than 10 cm for the sake of reliability and stability, otherwise it is likely to be caught due to improper operation. The control personnel should also be cautious when encountering undulating ground and reduce the speed of the robot.

7.About Climbing:

8.The rated forward climbing angle is less than or equal to 25°. Since the robot does not have a visual perception system at present, when using a large climbing angle (about equal to or greater than 25°), the robot body is likely to have a more lateral drift, especially when using the Trot gait; The visual perception system, which makes a direct turn on a slope with a large slope, is likely to destabilize the robot; when climbing the slope, please reduce the walking speed; it needs to be controlled by the controller.

9.About Speed:

The maximum speed can reach 3.3m/s under the stable control of flat terrain.

10.About the Robot Walking by the Track:

The official delivery version may support the robot on a flat or square track with pre-set conditions.

11.About the Robot Body Posture Adjustment Combined Action

(including pitch, roll, yaw, body height adjustment, etc.)

The official delivery version may support the standing state, level the ground, under the premise of pre-setting, the robot performs a series of body posture adjustment combined actions according to certain rules.

12.About Footpad:

The robot footpad is a consumable item, and we will give you an alternate footpad. Especially when running on rough ground, the wear will be more serious. If the obvious foot pad is found to be worn or damaged, or the impact noise on the ground is obviously increased when the robot is walking, please replace the foot pad in time to avoid damage to the foot. Foot sensor (such as force sensor).

13.It is forbidden to be complicated on the ground, the ground is slippery, there are debris on the ground, the terrain is undulating (step is higher than 10cm, etc.), the slope is larger (greater than 25°), and the robot is used when there is a sharp object on the ground or the periphery.

14.Carefully grip the joints at the joints, such as the knee joint.

## **Battery Pack Safety Guidelines**

Improper use, charging or storing the battery pack may result in fire or property and personal injury. Be sure to use the battery pack with reference to the safety instructions below.

## Use

1. Make sure the battery pack is fully charged before each use.
2. When using, moving or charging, please be careful of the battery and charging plug to avoid being damaged by external force.
3. When the battery pack is lower than two grids, stop using the robot as soon as possible, replace the new battery pack or charge the battery pack.
4. A battery that has just been used or a battery that has just been charged will have a certain amount of heat. This is normal, but be sure to let it sit for a while in a well-ventilated and empty place, wait for the battery to cool naturally before using it.
5. Do not allow the battery pack to come into contact with any liquid. Do not immerse the battery pack in liquid or get it wet. Do not use the battery pack in rain or in a damp environment. Decomposition reaction may occur after the inside of the battery pack contacts water, causing the battery pack to ignite spontaneously and may even cause an explosion.
6. It is strictly forbidden to use the battery pack that is not officially provided by Unitree. For replacement, please check the Unitree website for relevant purchase information. Unitree is not responsible for battery pack accidents caused by the use of battery packs not supplied by Unitree.
7. It is strictly forbidden to use a damaged, bulged, leaky battery pack.
8. Keep the battery pack powered off before installing or unplugging the battery pack. Do not plug or unplug the battery pack while the battery pack is powered on, otherwise the power supply or robot may be damaged.
9. The battery pack should be used between 5 °C and 35 °C. If the temperature is too high (above 40 °C), the battery pack may catch fire or even explode. If the temperature is too low (below 0 °C), the battery pack life will be seriously damaged.
10. Do not use the battery pack in strong magnetic or static environments. Otherwise, the battery pack protection board will malfunction, causing the battery pack and the robot to malfunction.
11. Do not disassemble or puncture the battery pack in any way.
12. The liquid inside the battery pack is highly corrosive. If there is leakage, please keep away. If the internal liquid is splattered onto human skin or eyes, rinse immediately with water for at least 15 minutes and seek medical attention immediately.
13. If the battery pack is severely impacted by external force, it must not be used again until the official inspection of Unitree is delivered.
14. If the battery pack is on fire, use solid-state fire-fighting equipment. It is recommended to use fire-fighting equipment in the following order: water or water mist, sand, fire blanket, dry powder, carbon dioxide fire extinguisher.



15. Do not place the battery pack in a pressure cooker or microwave oven.
16. Do not place the battery pack on the conductor plane.
17. Do not short circuit the positive and negative poles of the battery pack with wires or other metal objects.
18. Do not hit the battery pack. Do not place heavy objects on the battery pack or charger.
19. If there is dirt on the battery pack connector, wipe it off with a dry cloth. Failure to do so may result in poor contact, resulting in energy loss or failure to charge.

## Charging

1. The battery pack will automatically stop charging when it is fully charged. It is recommended to disconnect the charger after the battery pack is full.
2. Please be sure to plug in the charger when the battery is off.
3. When charging the battery, please ensure that the battery is charged in the line of sight to prevent unpredictable accidents.
4. When charging, please pay attention to ensure that the environment around the battery is well cooled, and there are no flammable and explosive materials such as sundries.
5. Keep the smart battery pack off when charging.
6. Smart battery packs must be recharged using a dedicated charger from Unitree. Unitree will not be responsible for any consequences of charging with a charger not supplied by Unitree.
7. When charging, please put the battery pack and charger on the ground without any flammable or combustible materials around the concrete floor. Please pay attention to the charging process to prevent accidents.
8. It is forbidden to charge the battery pack immediately after the robot has finished running. At this time, the battery pack is in a high temperature state, and forced charging may cause serious damage to the life of the battery pack. It is recommended to charge the battery pack to room temperature before charging. The ideal charging environment temperature (5 ° C -40 ° C) can greatly extend the life of the battery pack.
9. Disconnect the charger from the battery pack after charging is complete. Check and maintain the charger regularly, and check the appearance of the battery pack and other components. Never use alcohol or other flammable agents to clean the charger. Never use a damaged charger.

## Storage and Transportation

1. When not using the battery pack, remove the battery pack from the robot and store it in a dedicated battery case provided by Unitree.
2. Do not place the battery pack near a heat source, such as in a car that is exposed to direct sunlight or

hot weather, a fire source, or a heating furnace. The ideal storage temperature of the battery pack is 22 °C - 28 °C.

3. When storing, please pay attention to ensure that the environment around the battery is well cooled, and there are no flammable and explosive materials such as sundries.
4. The environment in which the battery pack is stored should be kept dry. Do not place the battery pack in water or where it may leak.
5. It is forbidden to mechanically impact, crush, puncture the battery pack, and it is forbidden to drop or short-circuit the battery pack.
6. Do not store or transport the battery pack with glasses, watches, metal necklaces, hair clips or other metal objects.
7. Do not transport damaged battery packs. Once you need to transport the battery pack, be sure to discharge the battery pack to about 65% charge.
8. Do not store the battery pack for a long time after it has been completely discharged, to prevent the battery pack from entering the over-discharge state, causing the battery to be damaged and cannot be used again.

### **Discard**

1. Always leave the battery pack completely discharged before placing the battery pack in the designated battery pack recycling bin. The battery pack is a dangerous chemical and is strictly prohibited from being disposed of in a common waste bin. For details, please follow the local battery pack recycling and disposal laws and regulations.

### **Maintenance**

1. Do not use the charger to charge the battery pack in an environment where the temperature is too high or the temperature is too low.
2. Do not store the battery pack in an environment where the room temperature exceeds 40 °C.
3. Do not overcharge the battery pack, otherwise it will cause damage to the battery core.
4. If you do not use the battery for a long time, please check the remaining battery power regularly. If the battery is lower than 30%, please charge the battery to 70% before saving. In order to avoid battery over-discharge and damage the battery.

# After-sales Policy

## Warranty Period

1. After you purchase the GO1 and other related products, robot warranty for one year, the warranty period starts from the day you receive the goods.
2. If the product of Unitree you purchased has exceeded the warranty period, you can also get our help by purchasing another service.
3. During the warranty period, without the permission of Unitree, if the clients do transformation, disassembly, and shell opening privately, the warranty period will be directly invalid..

## Maintenance Method

In accordance with specific circumstances, we will repair or replace the parts of Unitree products purchased by you correspondingly. However, the following circumstances will not be free warranty:

1. Damages caused by factitious factors rather than manufacturing factors;
2. Damage caused by transformation, disassembly, and shell opening privately, etc.;
3. Damages caused by improper installation, incorrect use, or operation not in accordance with official instructions or manuals;
4. Damage caused by the repairing and exchanging followed by a non-authorized service instructions or manuals;
5. Damages caused by unauthorized modification of circuits and misuse of the battery and the charger;
6. Damages caused by the operations in severe environment, such as strong magnetic disturbances, rain, dust storms, wetlands and other complex conditions;
7. Damage caused by operation in sharp terrain, undulating conditions, etc.;
8. Damage caused by operation on ground with very low friction (eg ice ground, glass ground);
9. Damage caused by falling damage (except for falls on flat terrain)
10. Damages caused by colliding with people or objects in the complex environments.
11. Damages caused by operating the product in an environment suffering from interference with other wireless devices , such as Wi-Fi signals, etc.;
12. Damages caused by overloading in excess of safe load conditions;
13. Damages caused by violence or non-violence in excess of the robot's anti-interference limits;
14. Damages caused by powering the robot with non-original battery;
15. Damages caused by compatibility and reliability issues when using the products of the third party;
16. Damages caused by forced operation in case of aging or damaging parts;

17. Damages caused by operating the unit with a low-charged or defective battery;
18. The relevant items are not sent within the specified time after contacting Unitree to confirm the warranty service;
19. Due to operational errors, the robot hits hard objects or falls down, there are obvious signs of collisions on the surface of the robot, and obvious traces of scratches.
20. There are obvious signs of dust, sand, water and metal powder intrusion inside the robot.
21. Due to the use of water in the humid environment, there are obvious water spots on the surface and inside of the robot, the components and boards have corrosion marks.
22. Under the developer mode, users use their own programs to develop high-level or low-level robots, resulting in damage to the robot without the protection of protective frame and protection rope. Including: When the high-level development, the robot carries users' own vision system to control the robot to move, the damage caused by the robot hitting a sharp object or falling down from the height; When the bottom-level development, the damage caused by the user-controlled motor hits the joint limit or other impacts, high-speed vibration of the motor; etc.

## Other Rules

1. When you send the product(s) to Unitree for return, repair or replacement, you are responsible for shipping costs.
2. Unitree will examine the returned product(s) to identify the problem. If the problem qualifies for service under this policy, Unitree will bear the cost for refund, replacement, or repair and return the product(s) at our cost to you.
3. If the product does not conform to the condition of free maintenance, you will have to pay the service. Unitree will not start repair until you agree to the cost for repair. If you disagree with the cost for repair, Unitree will return the product(s) with you burdening the cost of return shipping.
4. If the product exceeds the warranty scope, we will collect the corresponding inspection fees, replacement parts fees, test fees, labor fees and express fees in accordance to the specific issues.
5. Product maintenance may cause user-generated data loss. Therefore, please backup your data first.
6. Please do not send the seriously damaged battery back. If you have sent it back, Unitree will reject the battery and will not return it.

# Appendix

## Specifications

Chinese: [Unitree Robotics - 宇树科技官网](http://www.unitree.cc/)

English: <http://www.unitree.cc/>

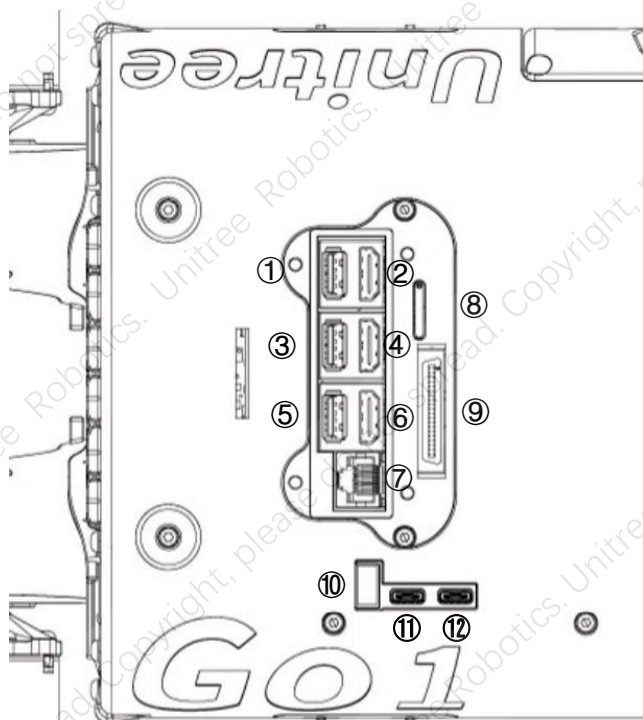

- 1.Nano-1 USB
- 2.Nano-1 HDMI
- 3.Nano-2 USB
- 4.Nano-2 HDMI
- 5.ARM- USB
- 6.ARM- HDMI
- 7.Gigabit Ethernet port
- 8.SIM
- 9.Integrated interface
- 10.Power supply port (24V 30A)
- 11.Coprocessor interface (Type-C)
- 12.Main processor interface (Type-C)